



since 2015

**Luca Lifestyle B.V.**  
**[www.lucalifestyle.com](http://www.lucalifestyle.com)**

De Peel 2, 4264 KK, Veen  
The Netherlands  
+31 (0) 416 72 50 03  
[info@lucalifestyle.com](mailto:info@lucalifestyle.com)

Version: 2026-01





## **LUCA LIFESTYLE**

### **Makes the world look better.**

In 2015, Luca Lifestyle was founded by owner Gerard van Tilborg, who saw opportunities in the market for high-quality planters with light weight and weather resistant properties. In cooperation with a Belgian university, a unique material composition based on polyester was developed. This material ensures that the planters are stable and scratch-resistant, ideal for both indoor and outdoor use.

Today, Luca Lifestyle is an international brand with premium dealers all over the world. As a wholesaler, we sell to a variety of customers; from garden centres to gardeners and project planters.

**EN**

---

In 2015 werd Luca Lifestyle opgericht door eigenaar Gerard van Tilborg, die kansen zag op het gebied van hoogwaardige plantenbakken met een licht gewicht en weerbestendige eigenschappen. In samenwerking met een Belgische universiteit werd een unieke materiaalsamenstelling ontwikkeld, gebaseerd op polyester. Dit materiaal zorgt ervoor dat de plantenbakken stabiel en krasbestendig zijn, ideaal voor zowel binnen- als buitengebruik.

Inmiddels is Luca Lifestyle een internationaal merk met verkooppunten over de hele wereld. Als groothandel verkopen we aan diverse klanten; van tuincentra tot hoveniers en projectbeplanters.

**NL**

---

Luca Lifestyle wurde 2015 vom Eigentümer Gerard van Tilborg gegründet, der Chancen im Bereich hochwertiger Pflanzgefäße mit geringem Gewicht und wetterfesten Eigenschaften gesehen hat. In Zusammenarbeit mit einer belgischen Universität wurde eine einzigartige Materialzusammensetzung auf Basis von Polyester entwickelt. Dieses Material sorgt dafür, dass die Pflanzgefäße stabil und kratzfest sind und sich sowohl für den Innen- als auch für den Außenbereich eignen.

Heute ist Luca Lifestyle eine internationale Marke mit Verkaufsstellen in der ganzen Welt. Als Großhändler verkaufen wir an eine Vielzahl von Kunden, von Gartenzentren bis hin zu Gärtnern und Projektplanern.

**DE**

---



# HANDMADE IN VIETNAM

**Luca Lifestyle planters are manufactured in Vietnam. The production of planters has long been deeply rooted in Vietnam, where high quality standards go hand in hand with attention to detail. Thanks to our own production facility in Vietnam, we are able to guarantee quality throughout the entire process, from production to delivery.**

In our factory, experienced craftsmen work with dedication on every detail of the production process. From shaping to finishing and inspecting the planters, everything is done with precision and care. This craftsmanship ensures that each planter is created with attention and love for the product.

We greatly value our collaboration with local craftsmen. Their dedication and expertise are at the heart of our production. To give something back to the community, we support a Vietnamese orphanage and children's hospital every year.

Each planter reflects the craftsmanship and passion of the artisans. The result is a product with a refined look and timeless elegance, reflecting respect for craftsmanship and tradition.

EN

**Luca Lifestyle plantenbakken worden geproduceerd in Vietnam. De productie van plantenbakken zit van oudsher diep geworteld in Vietnam, waar hoge kwaliteitseisen hand in hand gaan met oog voor detail. Dankzij onze eigen productiefaciliteit in Vietnam zijn wij in staat de kwaliteit in het gehele proces, van productie tot aan levering, te waarborgen.**

In onze fabriek werken ervaren ambachtslieden met toewijding aan elk detail van het productieproces. Van het vormen tot het afwerken en controleren van de plantenbakken, alles gebeurt met precisie en zorg. Dit vakmanschap zorgt ervoor dat elke plantenbak met aandacht en liefde voor het product tot stand komt.

Onze samenwerking met de lokale vakmensen waarderen wij zeer. Hun inzet en expertise vormen de kern van onze productie. Om iets terug te geven aan de gemeenschap ondersteunen wij jaarlijks een Vietnamees weeshuis en kinderziekenhuis.

Elke plantenbak weerspiegelt het vakmanschap en de passie van de ambachtslieden. Het resultaat is een product met een verfijnde uitstraling en een tijdloze elegantie, een weerspiegeling van respect voor vakmanschap en traditie.

NL

**Luca Lifestyle Pflanzgefäße werden in Vietnam hergestellt. Die Produktion von Pflanzgefäßen hat in Vietnam eine lange Tradition, wo hohe Qualitätsansprüche mit Liebe zum Detail einhergehen. Dank unserer eigenen Produktionsstätte in Vietnam können wir die Qualität während des gesamten Prozesses, von der Herstellung bis zur Lieferung, gewährleisten.**

In unserer Fabrik arbeiten erfahrene Handwerker mit Hingabe an jedem Detail des Produktionsprozesses. Von der Formgebung bis zur Fertigstellung und Kontrolle der Pflanzkübel wird alles mit Präzision und Sorgfalt ausgeführt. Diese Handwerkskunst sorgt dafür, dass jeder Pflanzkübel mit Aufmerksamkeit und Liebe zum Produkt hergestellt wird.

Wir schätzen die Zusammenarbeit mit den lokalen Fachkräften sehr. Ihr Engagement und ihr Fachwissen bilden den Kern unserer Produktion. Um der Gemeinschaft etwas zurückzugeben, unterstützen wir jedes Jahr ein vietnamesisches Waisenhaus und ein Kinderkrankenhaus.

Jeder Pflanzkübel spiegelt die Handwerkskunst und Leidenschaft der Handwerker wider. Das Ergebnis ist ein Produkt mit einer raffinierten Ausstrahlung und zeitloser Eleganz, das den Respekt vor Handwerkskunst und Tradition widerspiegelt.

DE





# TABLE OF CONTENTS

<b>22</b>	<b>Series &amp; colors</b>
<b>24</b>	<b>Shapes</b>
28	Cube
29	High Cube
32	Divider
34	Small Box
35	Box
38	Balloon
42	Low Balloon
43	Tall Balloon
50	Egg Pot
52	New Egg Pot
56	New Egg Pot Low
60	Tall Egg Pot
62	Modern Vase
66	Modern Pot
67	Modern Bowl
72	Elena
74	Bowl
78	Cylinder
80	Vase
84	Longtail
86	Combi
90	Organic
91	Organic Low
96	Decoration Stone
98	Wallhangers
<b>102</b>	<b>Luca x Suns: Rondello</b>
<b>110</b>	<b>Projects</b>
<b>128</b>	<b>Product information</b>



**Grigio**

**Terreno**





**Bordo**



**Ruvido**



**Argento**

# SERIES & COLORS

## Grigio



Antique White  
GW



Natural Concrete  
GN

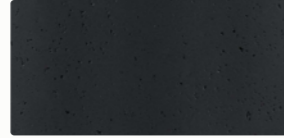

Anthracite  
GA

## Terreno

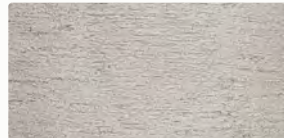

Sand  
TS



Clay  
TC

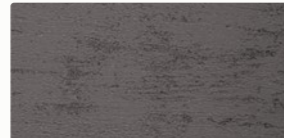

Ash Brown  
TA

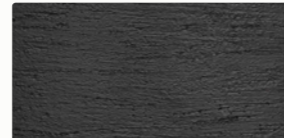

Earth  
TE

## Bordo



Sand  
BS



Clay  
BC

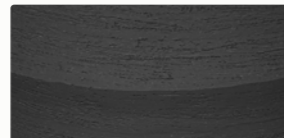

Earth  
BE

## Ruvido



Sand  
RS



Clay  
RC

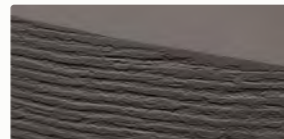

Ash Brown  
RA

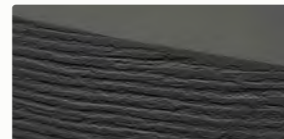

Earth  
RE

## Argento



Matt White  
AW



Black  
AB

## Extra - Decoration Stones & Wallhangers

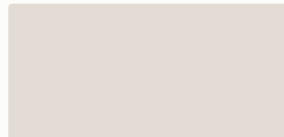

Sand



Clay



Ash Brown



Earth



# SHAPES

**Cube**  
28

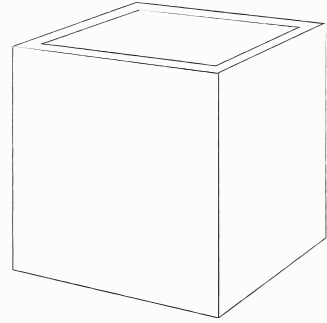

**High Cube**  
29

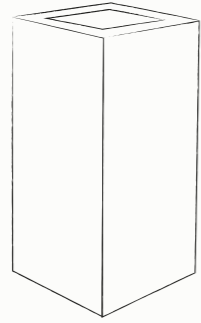

**Divider**  
32

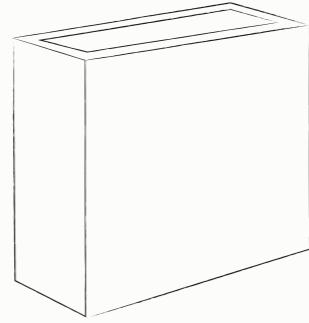

**Small Box**  
34

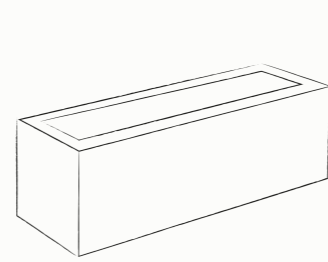

**Box**  
35

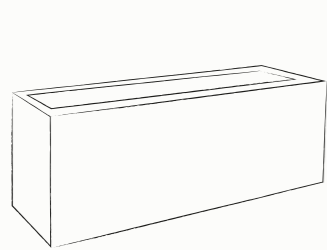

**Balloon**  
38

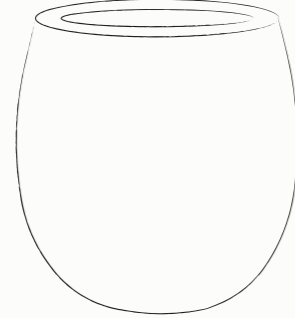

**Low Balloon**  
42

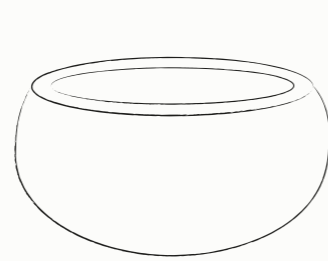

**Tall Balloon**  
43

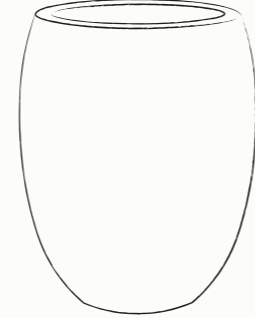

**Egg Pot**  
50

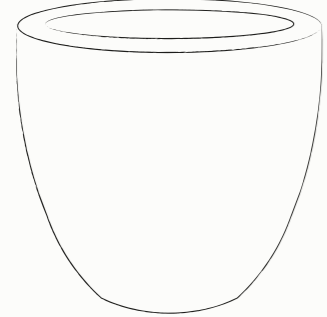

**New Egg Pot**  
52

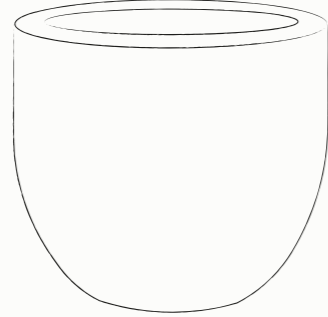

**New Egg Pot Low**  
56

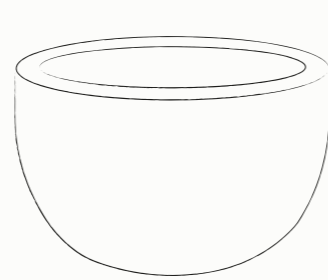

**Tall Egg Pot**  
60

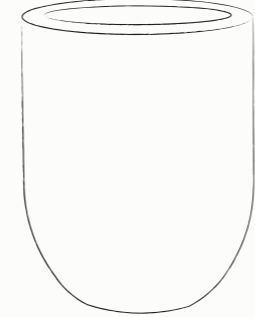

**Modern Vase**  
62



**Modern Pot**  
66

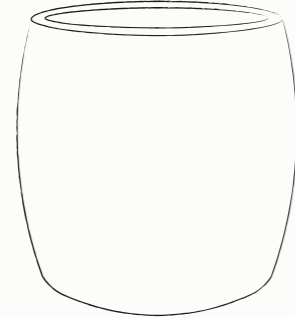

**Modern Bowl**  
67

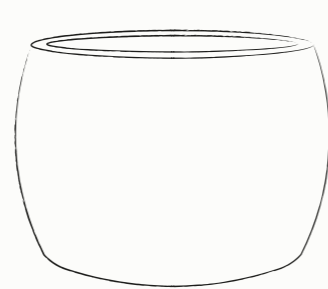

**Elena**  
72

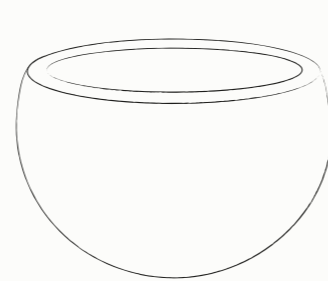

**Bowl**  
74

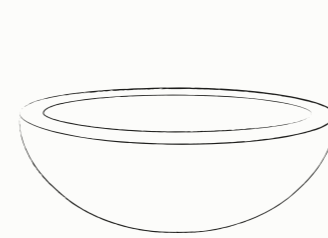

**Cylinder**  
78

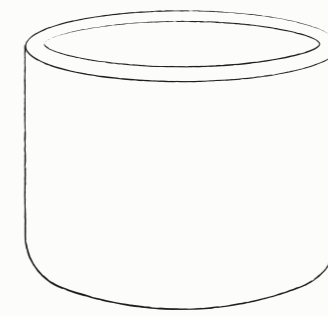

**Vase**  
80

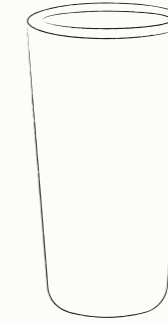

**Longtail**  
84

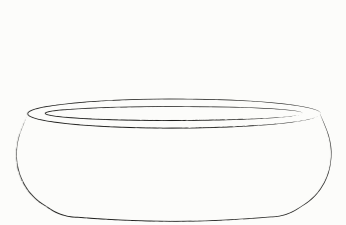

**Combi**  
86

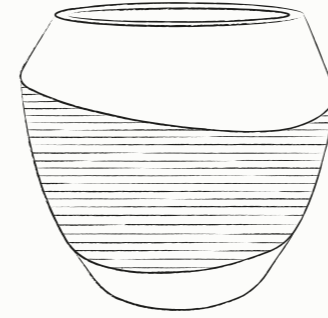

**Organic**  
90

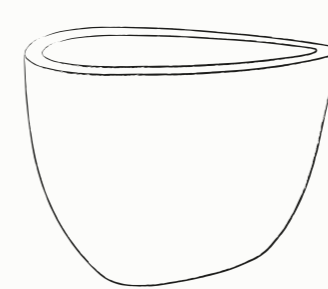

**Organic Low**  
91

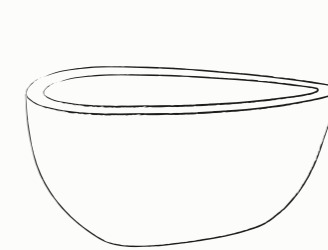

**Decoration Stone**  
96

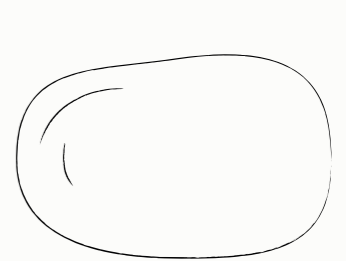

**Wallhanger #1**  
98

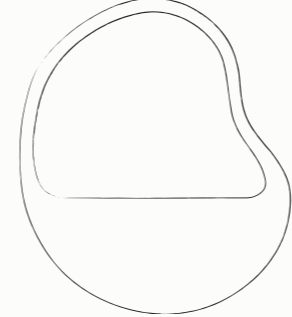

**Wallhanger #2**  
99

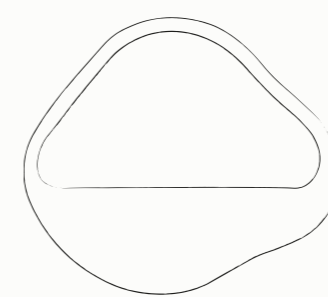

**Wallhanger #3**  
100

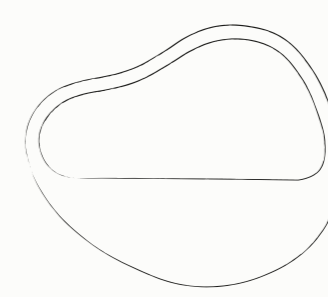

All dimensions in this catalog are given in centimeters (cm), weights in kilograms (kg), and volumes (at the back) in liters (L).



# ARTICLE NUMBERS

## Structure of the article numbers.

Our item numbers are designed so that each product is instantly recognizable.

The initial letters refer to the **collection** and **colour**, followed by a numerical code that indicates the **shape and size** of the item.

Thanks to this consistent structure, each item number is unique yet easy to trace back to its composition.

### **Example:**

Item number **TS202** – TS stands for the Terreno series in the colour Sand, and 202 refers to the Balloon shape with the size 55.

## Opbouw van de artikelnummers.

Onze artikelnummers zijn zo opgebouwd zodat elk product in één oogopslag herkenbaar is.

De beginletters verwijzen naar de **collectie** en **kleur**, gevolgd door een cijfercode die de **vorm en maat** van het artikel aanduidt.

Dankzij deze vaste structuur is elk artikelnummer uniek, maar toch eenvoudig te herleiden naar zijn samenstelling.

### **Voorbeeld:**

Artikelnummer **TS202** – hierbij staat TS voor de serie Terreno in de kleur Sand, en 202 verwijst naar de vorm Balloon met de afmeting 55.

## Aufbau der Artikelnummer.

Unsere Artikelnummern sind so aufgebaut, dass jedes Produkt auf den ersten Blick erkennbar ist.

Die Anfangsbuchstaben beziehen sich auf **Kollektion** und **Farbe**, gefolgt von einem Zahlencode, der **Form und Größe** des Artikels angibt.

Dank dieser festen Struktur ist jede Artikelnummer einzigartig und dennoch leicht auf ihre Zusammensetzung zurückzuführen.

### **Beispiel:**

Artikelnummer **TS202** – TS steht für die Terreno-Serie in der Farbe Sand, und 202 bezieht sich auf die Ballonform mit der Größe 55.

# Cube

Size	Opening	Weight	Art. code
30 x 30 x 30	24 x 24	3	101
40 x 40 x 40	33 x 33	6	102
50 x 50 x 50	42 x 42	10	103
60 x 60 x 60	50 x 50	16	104
80 x 80 x 80	66 x 66	22	105

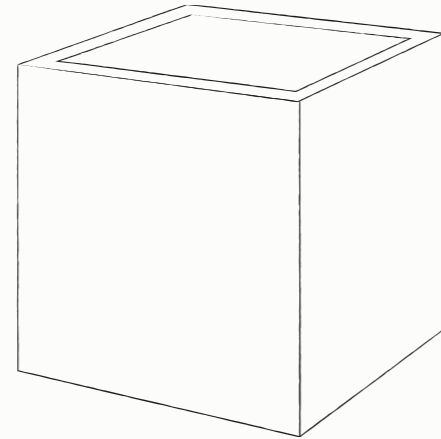

## Available in:

### Grigio



Antique White  
GW

Natural Concrete  
GN

Anthracite  
GA

### Terreno

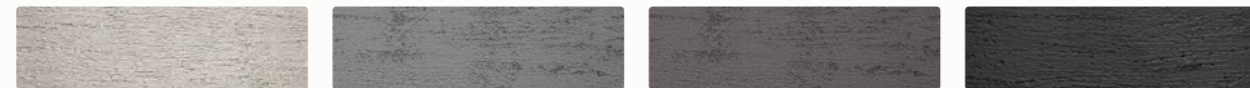

Sand  
TS

Clay  
TC

Ash Brown  
TA

Earth  
TE

### Argento



Matt White  
AW

Black  
AB

## Good to know #1 - wheels

Within the Grigio series, the Cube is also available with wheels in sizes 40, 50 and 60.

# High Cube

Size	Opening	Weight	Art. code
30 x 30 x 80	24 x 24	8	110
40 x 40 x 100	33 x 33	11	111

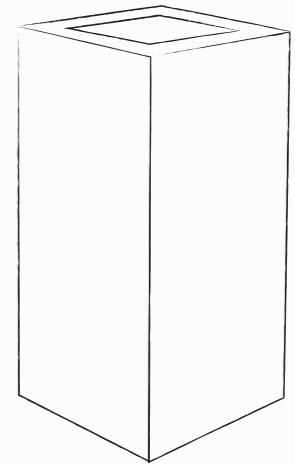

## Available in:

### Grigio



Antique White  
GW

Natural Concrete  
GN

Anthracite  
GA

### Terreno



Sand  
TS

Clay  
TC

Ash Brown  
TA

Earth  
TE

### Argento



Matt White  
AW

Black  
AB

## Good to know #2 - double bottom

The High Cube has a removable double bottom, so you only need to fill it partially before planting.



Grigio | High Cube - Antique White  
Grigio | Cube - Antique White



Terreno | Cube - Sand  
Terreno | Cube - Clay

# Divider

Size	Opening	Weight	Art. code
69 x 26 x 64	63 x 20	11	130
80 x 30 x 68	73 x 24	13	131
95 x 34 x 90	88 x 27	23	132

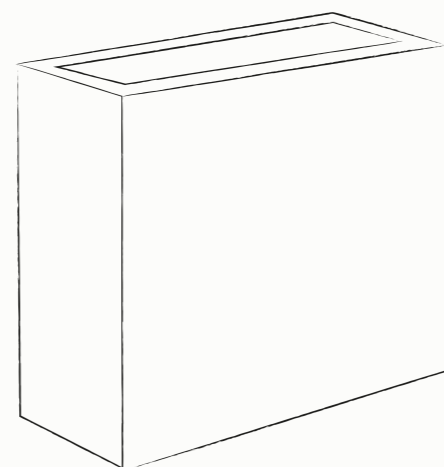

## Available in:

### Grigio



Antique White  
GW



Natural Concrete  
GN



Anthracite  
GA

### Terreno



Sand  
TS



Clay  
TC



Ash Brown  
TA



Earth  
TE

### Argento



Matt White  
AW



Black  
AB

## Good to know #3 - wheels

Within the Grigio series, the Divider is also available with wheels in sizes 68 and 90.



# Small Box

Size	Opening	Weight	Art. code
60 x 15 x 15	55 x 10	2	140
80 x 20 x 20	74 x 14	4	141
100 x 30 x 30	93 x 23	8	142

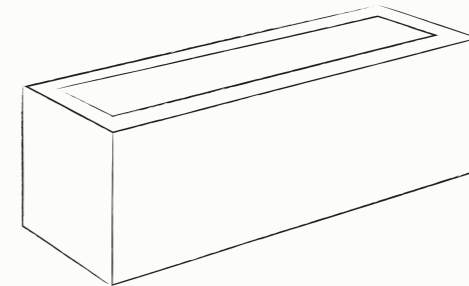

## Available in:

### Grigio



Antique White  
GW



Natural Concrete  
GN



Anthracite  
GA

### Argento



Matt White  
AW



Black  
AB

## Good to know #4 - mix and match

Angular shapes can be beautifully combined to create a playful and dynamic look. Mix and match different pieces within the same collection or experiment with colors to bring depth and harmony to your space. See page 36 for inspiration.

# Box

Size	Opening	Weight	Art. code
60 x 20 x 20	54 x 14	2	150
80 x 30 x 30	73 x 23	6	151
90 x 40 x 40	83 x 33	10	152
100 x 50 x 50	92 x 42	15	153
120 x 50 x 50	111 x 41	21	154
150 x 50 x 50	139 x 39	24	155

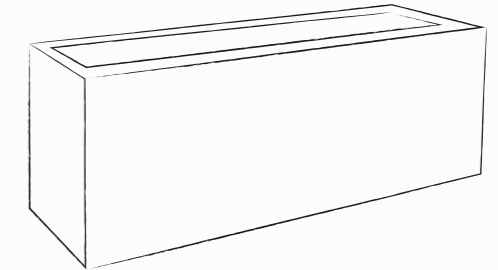

## Available in:

### Grigio

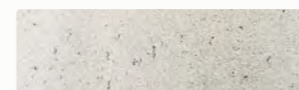

Antique White  
GW



Natural Concrete  
GN



Anthracite  
GA

### Terreno



Sand  
TS



Clay  
TC



Ash Brown  
TA



Earth  
TE

### Argento



Matt White  
AW



Black  
AB

## Good to know #5 - wheels

Within the Grigio series, the Box is also available with wheels in sizes 90 and 100.

Terreno | Divider - Clay  
Terreno | Box - Earth  
Terreno | Cube - Sand  
Terreno | Cube - Clay



# Balloon

Size	Opening	Weight	Art. code
30 x 30	Ø 21	2	200
42 x 42	Ø 31	4	201
55 x 55	Ø 42	8	202
70 x 70	Ø 58	19	203

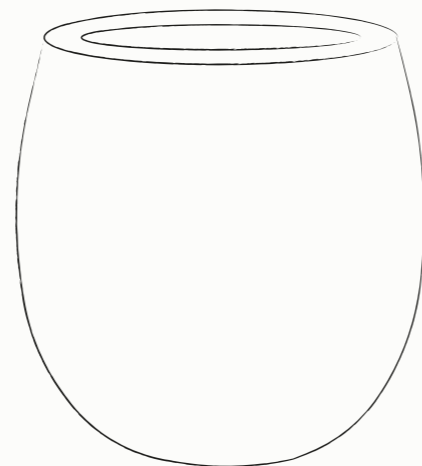

**Available in:**

**Grigio**

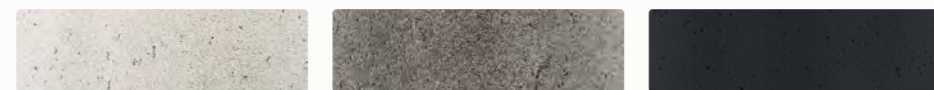

Antique White  
GW

Natural Concrete  
GN

Anthracite  
GA

**Terreno**

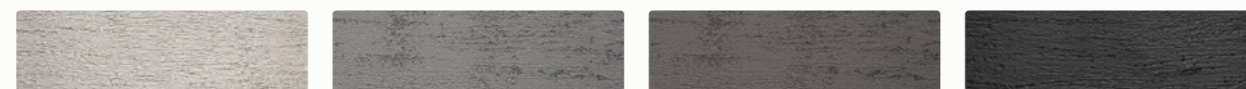

Sand  
TS

Clay  
TC

Ash Brown  
TA

Earth  
TE

**Bordo**



Sand  
BS

Clay  
BC

Earth  
BE

**Argento**



Matt White  
AW

Black  
AB





# Low Balloon

Size	Opening	Weight	Art. code
26 x 13	Ø 21	1	210
40 x 18	Ø 30	3	211
55 x 25	Ø 42	6	212
73 x 33	Ø 58	10	213
95 x 44	Ø 77	16	214
114 x 54	Ø 97	26	215

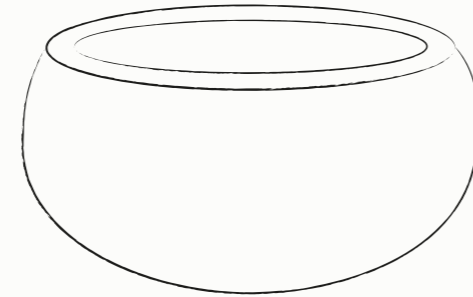

## Available in:

### Grigio

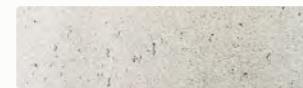

Antique White  
GW



Natural Concrete  
GN



Anthracite  
GA

### Terreno



Sand  
TS

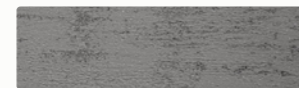

Clay  
TC



Ash Brown  
TA



Earth  
TE

## Good to know #6 - small planters

Our pots are best known for their impressive large sizes, but we also offer a variety of smaller shapes, such as the Low Balloon, Bowl (page 74), and Longtail (page 84). These compact designs are perfect as decorative pieces for your (garden) table.

# Tall Balloon

Size	Opening	Weight	Art. code
40 x 50	Ø 29	5	220
55 x 68	Ø 41	9	221
74 x 92	Ø 55	20	222

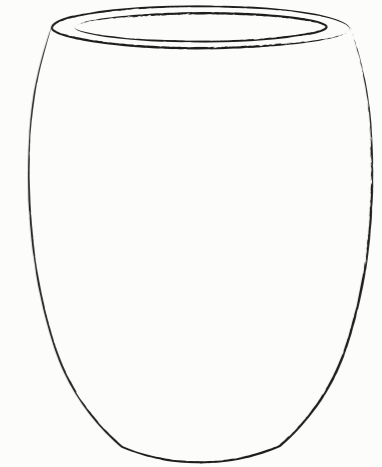

## Available in:

### Grigio

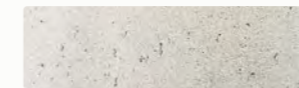

Antique White  
GW



Natural Concrete  
GN



Anthracite  
GA

### Terreno



Sand  
TS

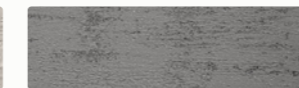

Clay  
TC



Ash Brown  
TA



Earth  
TE

### Bordo



Sand  
BS



Clay  
BC

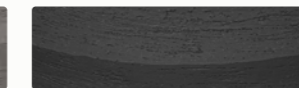

Earth  
BE

### Argento

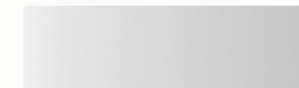

Matt White  
AW



Black  
AB



Terreno | Tall Balloon - Sand

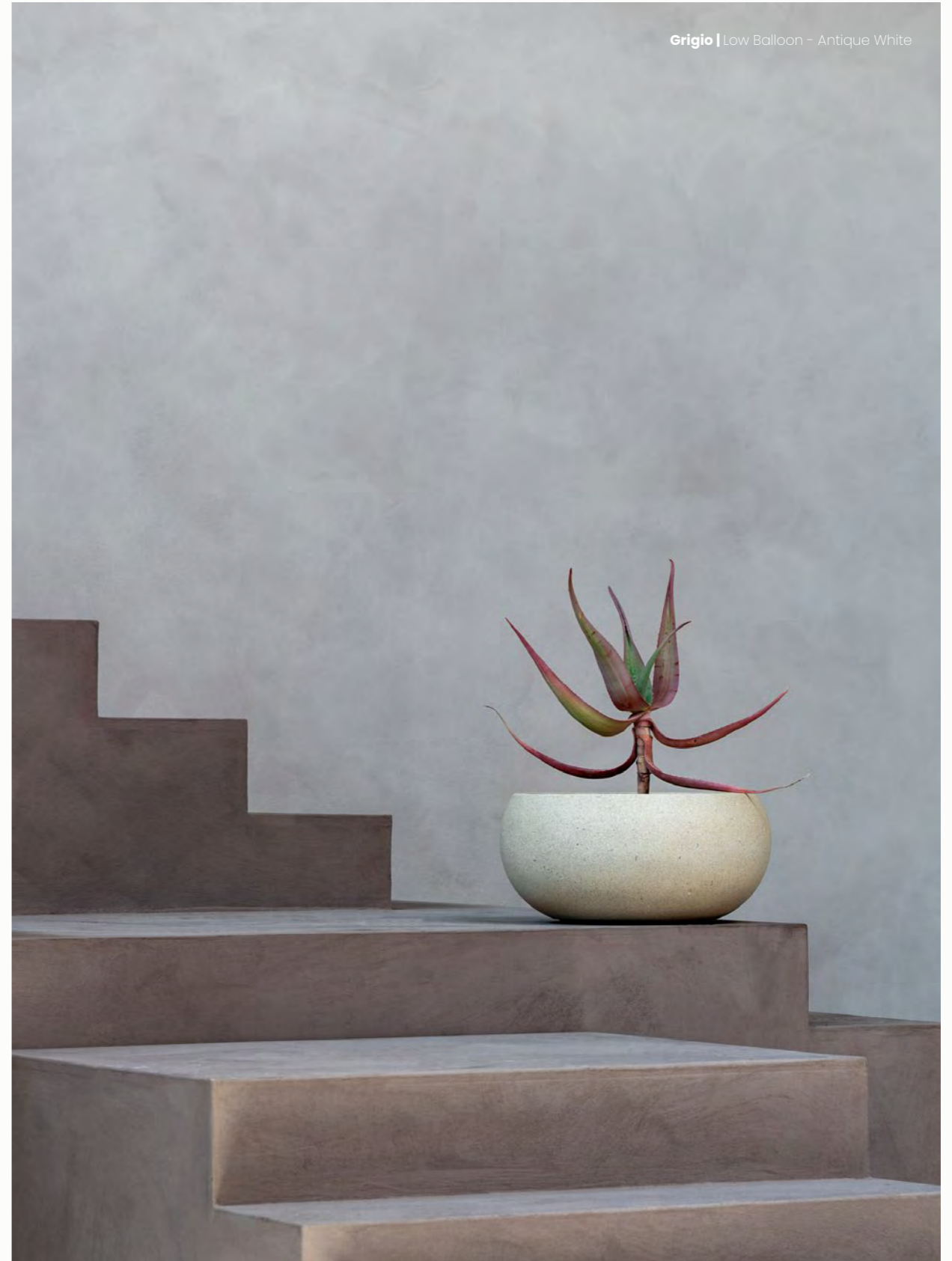

Grigio | Low Balloon - Antique White





Grigio | Tall Balloon - Antique White

# Egg Pot

Size	Opening	Weight	Art. code
32 x 29	Ø 28	2	300
40 x 36	Ø 35	3	301
50 x 45	Ø 44	6	302
60 x 54	Ø 53	9	303

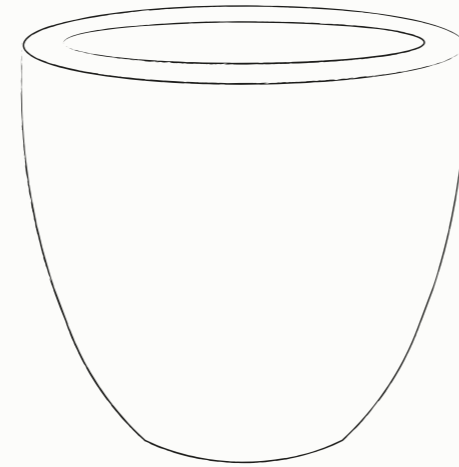

## Available in:

### Grigio

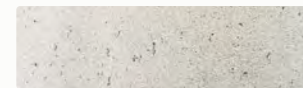

Antique White  
GW



Natural Concrete  
GN



Anthracite  
GA

## Good to know #7 - Egg series

The Egg Pot has been part of the Luca Lifestyle range since the company was founded in 2015 and is still one of our best-selling shapes. If you are looking for a timeless classic, the Egg Pot is the perfect choice. Looking for an addition or alternative to this pot? Take a look at the following pages to see the other shapes in the 'Egg' series.



Grigio | Egg Pot - Natural Concrete  
Grigio | Egg Pot - Anthracite  
Grigio | Egg Pot - Antique White

# New Egg Pot

Size	Opening	Weight	Art. code
36 x 31	Ø 30	3	310
45 x 38	Ø 37	4	311
55 x 46	Ø 47	6	312
65 x 54	Ø 55	10	313
80 x 66	Ø 68	16	314
94 x 80	Ø 83	28	315

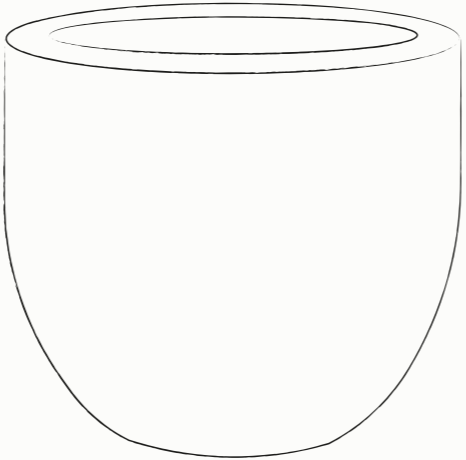

**Available in:**

**Grigio**



**Terreno**

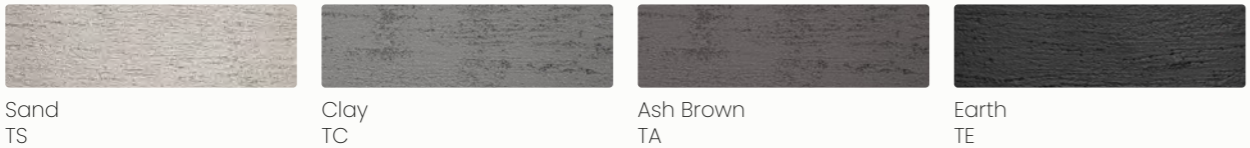

**Bordo**



**Argento**

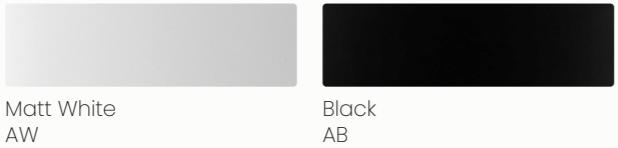

Terreno | New Egg Pot - Ash Brown  
Terreno | New Egg Pot - Earth



Argento | New Egg Pot - Black



# New Egg Pot Low

Size	Opening	Weight	Art. code
80 x 47	Ø 72	13	320
94 x 56	Ø 84	20	321
110 x 65	Ø 100	27	322

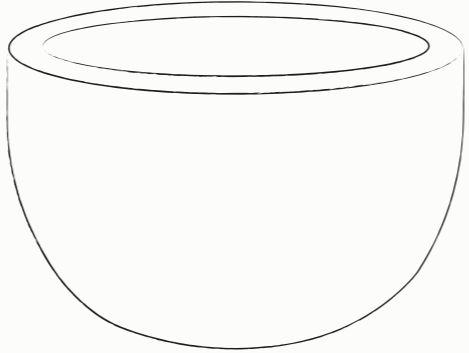

**Available in:**

**Grigio**



**Terreno**

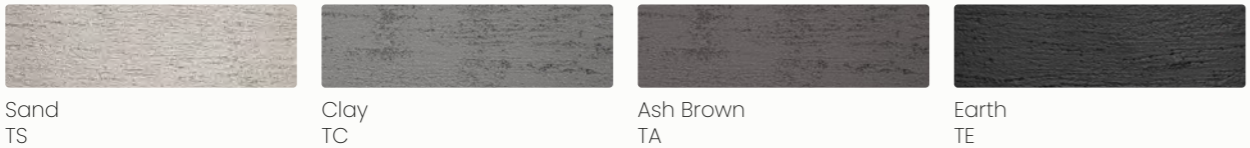

**Bordo**



**Good to know #8** - 10 year anniversary

Luca Lifestyle was founded in 2015 and proudly marks a decade of craftsmanship and style.



Bordo | New Egg Pot Low - Sand



# Tall Egg Pot

Size	Opening	Weight	Art. code
30 x 35	Ø 24	3	330
40 x 47	Ø 33	5	331
52 x 61	Ø 44	10	332
68 x 80	Ø 58	18	333
88 x 103	Ø 77	27	334

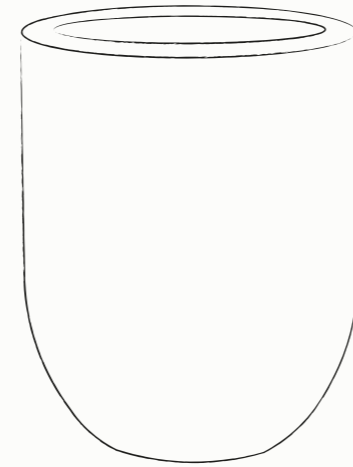

## Available in:

### Grigio

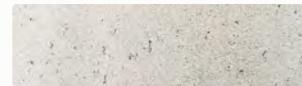

Antique White  
GW



Natural Concrete  
GN



Anthracite  
GA

## Good to know #9 - Pot Feet

We also offer a range of practical accessories, including our Pot Feet. These small supports are placed under the planter pots to ensure proper drainage and prevent water from getting trapped. Available in the Grigio colors Antique White, Natural Concrete, and Anthracite, they come in light, medium, and dark tones that blend easily with pots in any color. Often, they can be positioned discreetly so they remain out of sight while still doing their job. Find more information about Pot Feet on page 134.



# Modern Vase

Size	Opening	Weight	Art. code
30 x 70	Ø 21	6	400
42 x 90	Ø 31	10	401
55 x 110	Ø 41	17	402

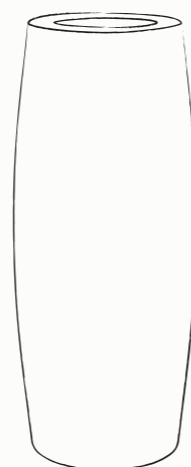

## Available in:

### Grigio



Antique White  
GW



Natural Concrete  
GN



Anthracite  
GA

### Bordo



Sand  
BS



Clay  
BC



Earth  
BE

## Good to know #10 - Coverplates

Designed for versatility, our Coverplates fit seamlessly on the Modern Vases and High Cubes, allowing you to create beautiful pedestals with ease. Perfect for elevating your favorite plants or design pieces, they add a modern touch to any environment. More information about the Coverplates on page 134.





# Modern Pot

---

Size	Opening	Weight	Art. code
34 x 34	Ø 24	3	410
44 x 44	Ø 35	5	411
55 x 55	Ø 44	10	412
68 x 68	Ø 56	18	413

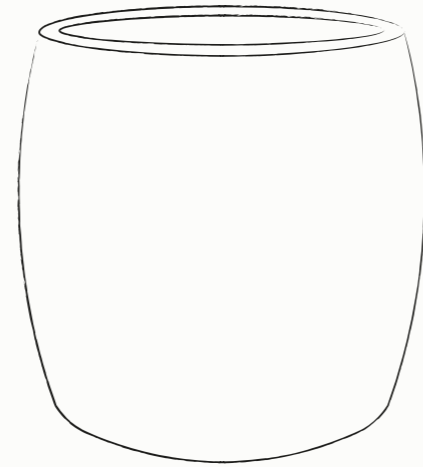

## Available in:

### Grigio



Antique White  
GW



Natural Concrete  
GN



Anthracite  
GA

## Good to know #11 - showroom visit

---

Visit our two showrooms in Veen, the Netherlands, and explore our full range of series, shapes, and colors. Experience the quality of our pots firsthand; feel the materials, see the finishes, and appreciate the proportions that reflect true craftsmanship. Whether you're seeking inspiration, choosing the ideal combination for a project, or simply wish to discover our designs up close, our team is ready to welcome you and help you find the perfect match.

# Modern Bowl

---

Size	Opening	Weight	Art. code
50 x 31	Ø 40	5	420
60 x 37	Ø 50	9	421
74 x 45	Ø 61	13	422
90 x 55	Ø 75	20	423
110 x 67	Ø 92	27	424

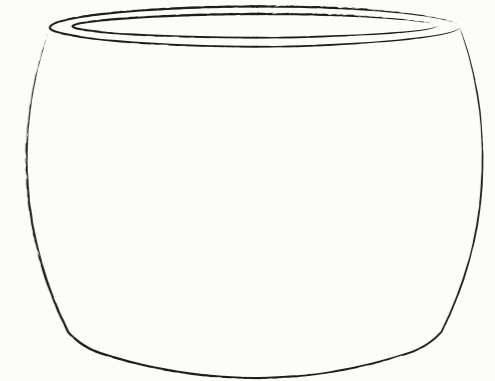

## Available in:

### Grigio

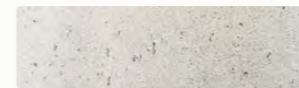

Antique White  
GW



Natural Concrete  
GN



Anthracite  
GA

## Good to know #12 - Modern series

---

The Modern shapes were developed with feedback from professional landscapers, combining elegant design with practical functionality. Thanks to their wide, sturdy base, the pot remains stable at all times, even when holding a large tree. This makes them ideal for outdoor spaces where both aesthetics and reliability matter, ensuring your greenery stays securely in place no matter the weather.





# Elena

Size	Opening	Weight	Art. code
50 x 31	Ø 39	4	500
70 x 44	Ø 56	9	501
90 x 57	Ø 73	15	502
120 x 75	Ø 95	40	503

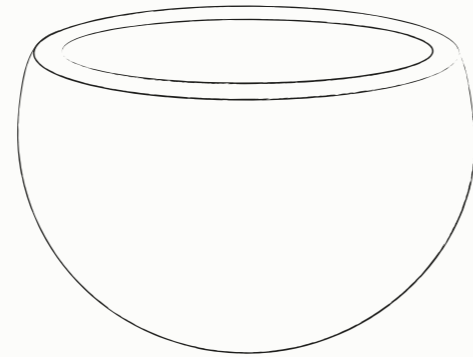

**Available in:**

**Grigio**



Antique White  
GW



Natural Concrete  
GN



Anthracite  
GA

**Terreno**



Sand  
TS

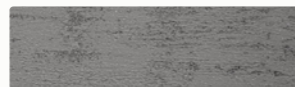

Clay  
TC



Ash Brown  
TA



Earth  
TE

**Good to know #13** - largest planter

The Elena comes in several sizes, with the largest measuring 120 cm in diameter, making it the biggest piece in our collection. Its generous size makes it perfect as a standout element, adding presence and balance to any space.



# Bowl

Size	Opening	Weight	Art. code
40 x 18	Ø 34	2	540
50 x 21	Ø 43	4	541

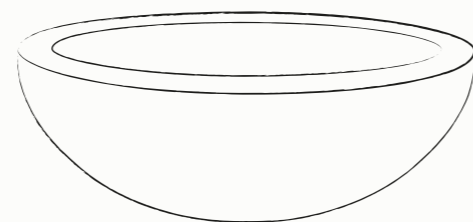

## Available in:

### Grigio



Antique White  
GW



Natural Concrete  
GN



Anthracite  
GA

## Good to know #14 - large stock

All our products are available for quick delivery from our warehouse in Veen when in stock. We keep a large inventory to ensure orders are delivered on time. If the product you're looking for isn't available, our team will be happy to help you find a suitable alternative. For larger quantities or regular stock orders, direct container shipments can also be arranged from our factory in Vietnam.





Terreno | Bowl - Sand  
Terreno | Bowl - Clay

# Cylinder

---

Size	Opening	Weight	Art. code
48 x 32	Ø 40	5	510
60 x 41	Ø 50	9	511
80 x 61	Ø 66	20	512

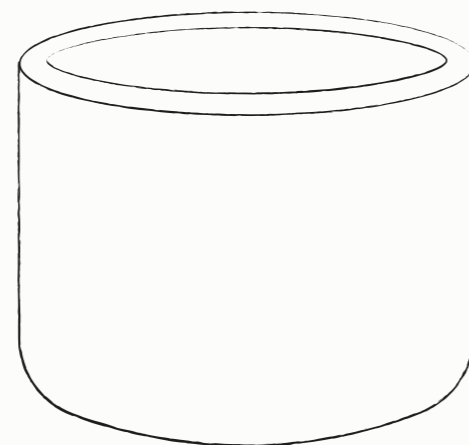

## Available in:

### Grigio



Antique White  
GW



Natural Concrete  
GN



Anthracite  
GA

## Good to know #15 - weather resistant

---

Our pots are designed to withstand a wide range of weather conditions. From -25°C to +65°C, they won't crack or suffer damage from extreme temperatures. This makes them not only highly durable but also suitable for use anywhere in the world, giving you flexibility and peace of mind for all your outdoor projects.



# Vase

Size	Opening	Weight	Art. code
36 x 68	Ø 30	6	530
47 x 90	Ø 39	11	531

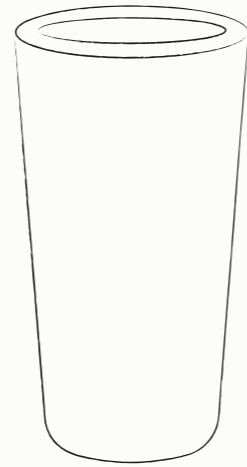

## Available in:

### Grigio



Antique White  
GW



Natural Concrete  
GN



Anthracite  
GA

### Terreno



Sand  
TS



Clay  
TC



Ash Brown  
TA

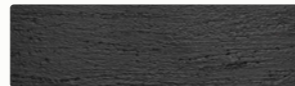

Earth  
TE

### Argento



Matt White  
AW



Black  
AB

## Good to know #16 - double bottom

The Vase has a removable double bottom, so you only need to fill it partially before planting.



Grigio | Vase - Anthracite  
Argento | Vase - Black  
Terreno | Vase - Earth



# Longtail

Size	Opening	Weight	Art. code
45 x 20 x 15	39 x 17	2	535
65 x 32 x 20	58 x 25	4	536

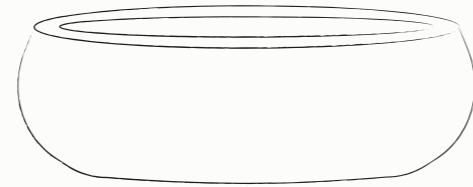

## Available in:

### Grigio

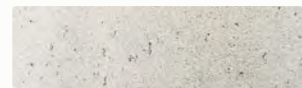

Antique White  
GW



Natural Concrete  
GN



Anthracite  
GA

### Terreno



Sand  
TS



Clay  
TC



Ash Brown  
TA



Earth  
TE

## Good to know #17 - warranty

Thanks to the quality and timeless design of our pots, we can offer a *5-year warranty* on every product. We believe in providing our customers with lasting satisfaction and reliable service. This commitment reflects our dedication to craftsmanship and ensures that your investment in our pots continues to bring beauty and functionality for years to come.



# Combi

Size	Opening	Weight	Art. code
54 x 47	Ø 36	9	600
80 x 70	Ø 55	18	601

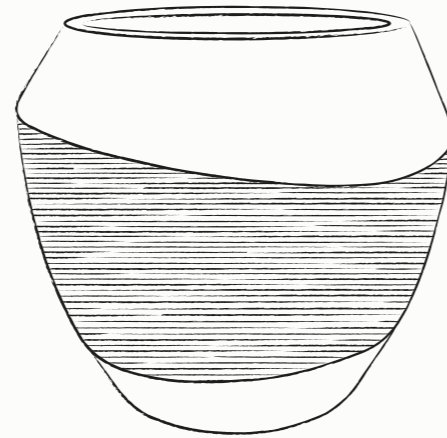

## Available in:

### Ruvido



Sand  
RS

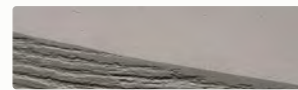

Clay  
RC



Ash Brown  
RA



Earth  
RE

## Good to know #18 - 3D models

We offer 3D models for every shape, easily downloadable through our B2B portal. These files make it simple to visualize the pots in a garden or interior design, helping you show your clients exactly why a pot can be a perfect addition to any space.





# Organic

Size	Opening	Weight	Art. code
67 x 50	Ø 48	10	610
80 x 60	Ø 57	15	611
93 x 70	Ø 66	22	612

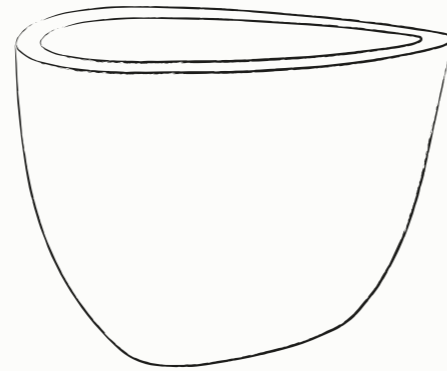

## Available in:

### Ruvido



Sand  
RS



Clay  
RC



Ash Brown  
RA



Earth  
RE

## Good to know #19 - Flexible Plastic Inserts

We also offer Flexible Plastic Inserts for every pot shape. These inserts are specially designed for indoor use, making your pots completely watertight and easy to maintain. They can be bent to perfectly fit the shape of the pot and trimmed if they are too tall, providing a custom fit for every situation. This practical accessory ensures that your indoor space stays safe from water damage while keeping the pot looking clean and elegant. Find more information on page 134.

# Organic Low

Size	Opening	Weight	Art. code
67 x 30	Ø 48	6	615
80 x 40	Ø 57	10	616
93 x 50	Ø 66	16	617

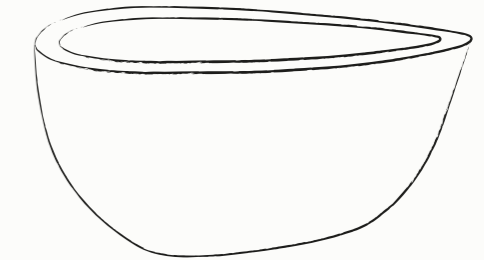

## Available in:

### Ruvido



Sand  
RS



Clay  
RC



Ash Brown  
RA



Earth  
RE

## Good to know #20 - handmade

All our products are handmade in Vietnam, making each piece unique and special. The craftsmanship behind every pot gives it its own character and charm. Because of this handmade process, minor variations in size, weight, or color may occur. These minimal differences are part of the product's natural look and a reflection of the care and authenticity that go into every piece.





Ruvido | Organic - Clay



# Decoration Stones

---

Size	Weight	Art. code
60 x 42 x 33	6	850
70 x 52 x 43	10	851
80 x 62 x 53	14	852

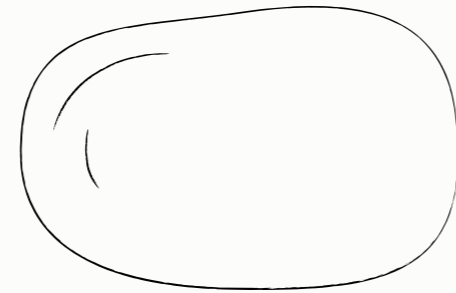

## Available in:

### Extra

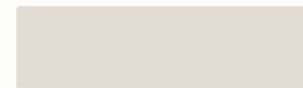

Sand  
DS



Clay  
DC



Ash Brown  
DA



Earth  
DE

## Good to know #21 - Decoration Stones

---

Decoration Stones offer a simple and stylish way to enhance any garden. They are ideal for areas where planting is limited or for spaces that already have plenty of greenery, providing visual interest without overcrowding. With colors that coordinate seamlessly with the Terreno, Bordo, and Ruvido collections, these stones are versatile and can be used throughout your outdoor space to create texture, balance, and a cohesive look.



# Wallhanger #1

---

Size	Weight	Art. code
40 x 35 x 8	1	860
50 x 43 x 8	2	863

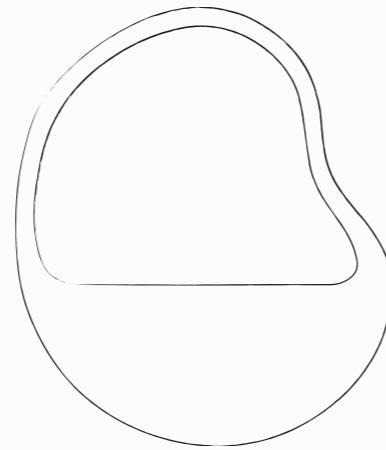

## Available in:

### Extra



Sand  
WS



Clay  
WC



Earth  
WE

## Good to know #22 - Wallhangers

---

Our Wallhangers are the perfect accessory for your patio, office, or interior spaces. They are available in three timeless colors that coordinate beautifully with the Terreno, Bordo, and Ruvido collections, making them versatile and easy to integrate into any setting.

# Wallhanger #2

---

Size	Weight	Art. code
35 x 40 x 8	1	861
43 x 50 x 8	2	864

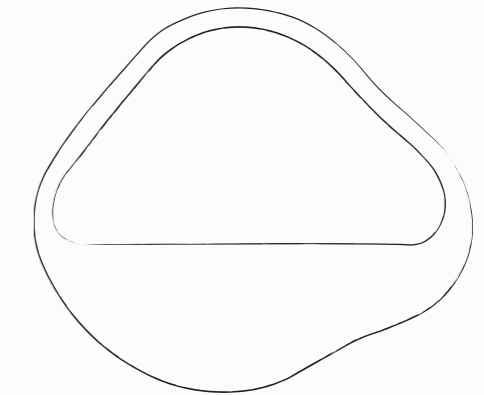

## Available in:

### Extra



Sand  
WS



Clay  
WC



Earth  
WE

## Good to know #23 - Samplebox

---

We offer a unique Samplebox containing miniature pots of every color in each of our collections. It's the perfect way to give your clients a realistic impression of our range, as well as the look and feel of a Luca Lifestyle planter. The Samplebox is available via our B2B portal.

# Wallhanger #3

Size	Weight	Art. code
35 x 40 x 8	1	862
43 x 50 x 8	2	865

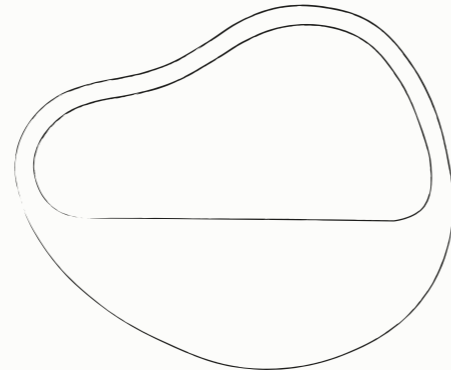

## Available in:

### Extra

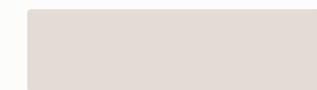

Sand  
WS



Clay  
WC



Earth  
WE

## Good to know #24 - feedback

At Luca Lifestyle, we are always open to hearing your thoughts on our products. You can easily reach out to one of our team members by phone or email to share your feedback. We are looking forward to hearing from you!

Wallhanger #1 | Earth  
Wallhanger #3 | Clay



# RONDELLO



Luca Lifestyle and Suns have joined forces to develop a unique product: the **Rondello**. This special design, available as a pot and a vase, is the result of our combined creativity and expertise. The Rondello is available in three beautiful colors and shows what is possible when two parties come together to create something special.

Luca Lifestyle en Suns hebben de handen ineengeslagen om een uniek product te ontwikkelen: de **Rondello**. Dit bijzondere ontwerp, dat verkrijgbaar is als pot en als vaas, is het resultaat van onze gezamenlijke creativiteit en expertise. De Rondello is beschikbaar in drie prachtige kleuren en laat zien wat er mogelijk is wanneer twee partijen samenkomen om iets bijzonders te creëren.

Luca Lifestyle und Suns haben sich zusammengetan, um ein einzigartiges Produkt zu entwickeln: den **Rondello**. Dieses besondere Design, das als Topf und als Vase erhältlich ist, ist das Ergebnis unserer gemeinsamen Kreativität und Expertise. Der Rondello ist in drei wunderschönen Farben erhältlich und zeigt, was möglich ist, wenn zwei Parteien zusammenkommen, um etwas Besonderes zu schaffen.





All information about the Rondello is available on our B2B portal. The products can be ordered via both Suns and Luca Lifestyle.

Alle informatie over de Rondello is beschikbaar op ons B2B-portaal. De producten zijn te bestellen via zowel Suns als Luca Lifestyle.

Alle Informationen zum Rondello finden Sie auf unserem B2B-Portal. Die Produkte können sowohl über Suns als auch über Luca Lifestyle bestellt werden.





# PROJECTS HIGHLIGHTED

## Inspired by our customers.

Long-term collaborations with our customers are at the heart of what we do. We greatly value the relationships we build over time and are grateful for the trust our clients place in us.

The insights and feedback they share are invaluable, helping us to develop new collections, colors, and designs that truly meet the needs of the market.

We encourage our clients to share their projects and experiences with us. It inspires us, strengthens our collaboration, and contributes to creating products we can be proud of together.

EN

---

Bij ons staan langdurige samenwerkingen met onze klanten centraal. We hechten veel waarde aan de band die we in de loop der tijd opbouwen en zijn dankbaar voor het vertrouwen dat onze klanten in ons stellen.

De inzichten en feedback die klanten met ons delen, zijn van onschatbare waarde. Ze helpen ons bij het ontwikkelen van nieuwe collecties, kleuren en vormen, zodat onze producten altijd aansluiten bij de wensen en behoeften van de markt.

We moedigen onze klanten dan ook aan om hun projecten en ervaringen met ons te delen. Het inspireert ons, versterkt onze samenwerking en draagt bij aan het creëren van producten waar we samen trots op kunnen zijn.

NL

---

Langfristige Zusammenarbeit mit unseren Kunden steht bei uns im Mittelpunkt. Wir legen großen Wert auf die Beziehungen, die wir im Laufe der Zeit aufbauen, und sind dankbar für das Vertrauen, das uns unsere Kunden entgegenbringen.

Die Einblicke und das Feedback, das sie mit uns teilen, sind von unschätzbarem Wert und helfen uns, neue Kollektionen, Farben und Designs zu entwickeln, die den Bedürfnissen des Marktes gerecht werden.

Wir ermutigen unsere Kunden, ihre Projekte und Erfahrungen mit uns zu teilen. Das inspiriert uns, stärkt die Zusammenarbeit und trägt dazu bei, Produkte zu schaffen, auf die wir gemeinsam stolz sein können.

DE

---

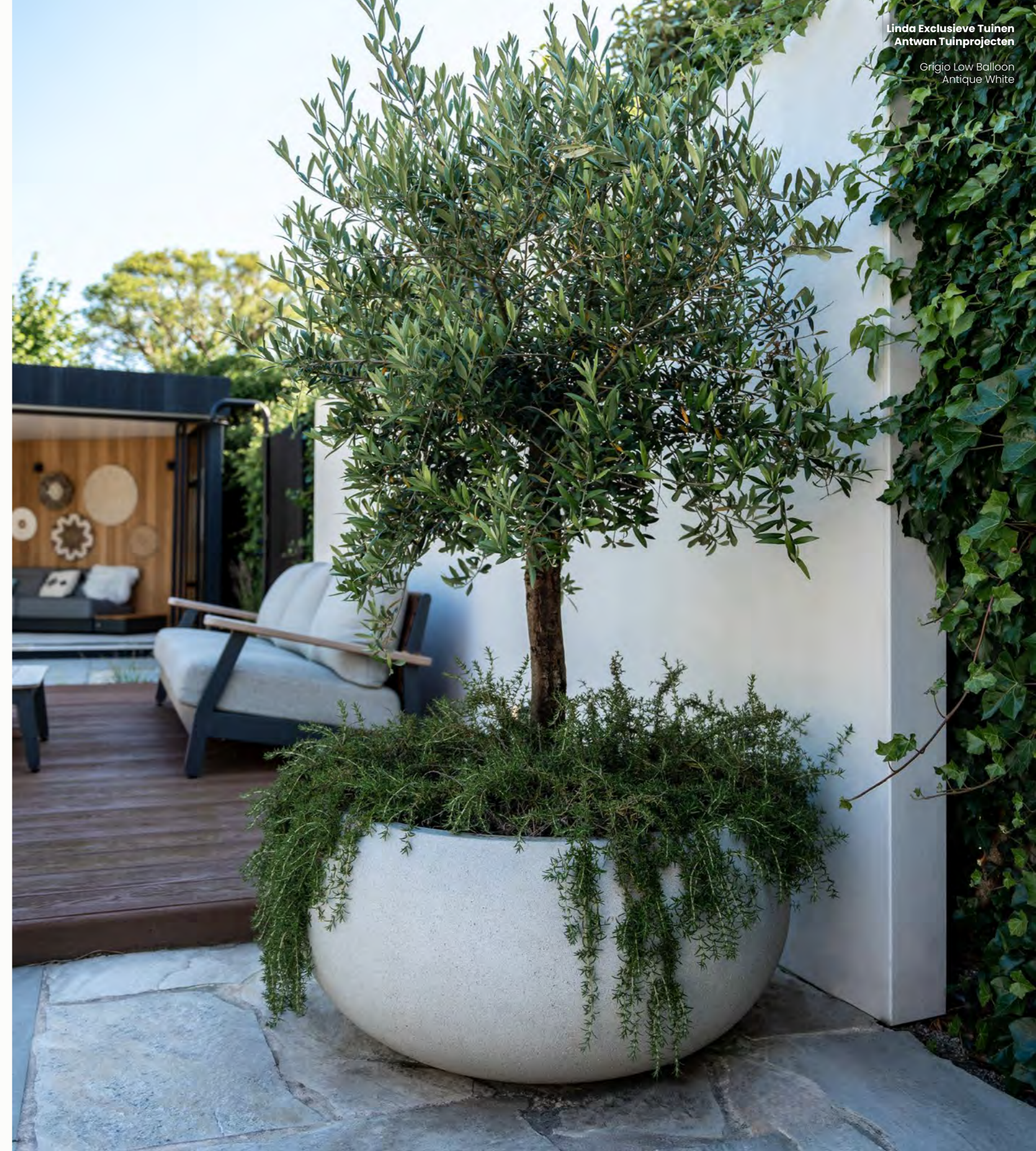

















# GRIGIO



Shape	Name	Size	Opening	Weight	Volume	Antique White	Natural Concrete	Anthracite
	Grigio Cube 30	30 x 30 x 30	24 x 24	3	27	GW101	GN101	GA101
	Grigio Cube 40	40 x 40 x 40	33 x 33	6	64	GW102	GN102	GA102
	Grigio Cube 50	50 x 50 x 50	42 x 42	10	125	GW103	GN103	GA103
	Grigio Cube 60	60 x 60 x 60	50 x 50	16	216	GW104	GN104	GA104
	Grigio Cube 80	80 x 80 x 80	66 x 66	22	512	GW105	GN105	GA105
	Grigio Cube 40 - wheels	40 x 40 x 40	33 x 33	6	64	GW190	GN190	GA190
	Grigio Cube 50 - wheels	50 x 50 x 50	42 x 42	10	125	GW191	GN191	GA191
	Grigio Cube 60 - wheels	60 x 60 x 60	50 x 50	16	216	GW192	GN192	GA192
	Grigio High Cube 80	30 x 30 x 80	24 x 24	8	72	GW110	GN110	GA110
	Grigio High Cube 100	40 x 40 x 100	33 x 33	11	160	GW111	GN111	GA111
	Grigio Divider 64	69 x 26 x 64	63 x 20	11	115	GW130	GN130	GA130
	Grigio Divider 68	80 x 30 x 68	73 x 23	13	163	GW131	GN131	GA131
	Grigio Divider 90	95 x 34 x 90	88 x 27	23	290	GW132	GN132	GA132
	Grigio Divider 68 - wheels	80 x 30 x 68	73 x 23	13	163	GW193	GN193	GA193
	Grigio Divider 90 - wheels	95 x 34 x 90	88 x 27	23	290	GW194	GN193	GA194
	Grigio Small Box 60	60 x 15 x 15	55 x 10	2	14	GW140	GN140	GA140
	Grigio Small Box 80	80 x 20 x 20	74 x 14	4	32	GW141	GN141	GA141
	Grigio Small Box 100	100 x 30 x 30	93 x 23	8	90	GW142	GN142	GA142
	Grigio Box 60	60 x 20 x 20	54 x 14	2	24	GW150	GN150	GA150
	Grigio Box 80	80 x 30 x 30	73 x 23	6	72	GW151	GN151	GA151
	Grigio Box 90	90 x 40 x 40	83 x 33	10	144	GW152	GN152	GA152
	Grigio Box 100	100 x 50 x 50	92 x 42	15	250	GW153	GN153	GA153
	Grigio Box 120	120 x 50 x 50	111 x 41	21	300	GW154	GN154	GA154
	Grigio Box 150	150 x 50 x 50	139 x 39	24	375	GW155	GN155	GA155
	Grigio Box 90 - wheels	90 x 40 x 40	83 x 33	10	144	GW195	GN195	GA195
	Grigio Box 100 - wheels	100 x 50 x 50	92 x 42	15	250	GN196	GN196	GA196
	Grigio Balloon 30	30 x 30	Ø 21	2	16	GW200	GN200	GA200
	Grigio Balloon 42	42 x 42	Ø 31	4	40	GW201	GN201	GA201
	Grigio Balloon 55	55 x 55	Ø 42	8	90	GW202	GN202	GA202
	Grigio Balloon 70	70 x 70	Ø 58	19	210	GW203	GN203	GA203
	Grigio Low Balloon 26	26 x 13	Ø 21	1	6	GW210	GN210	GA210
	Grigio Low Balloon 40	40 x 18	Ø 30	3	20	GW211	GN211	GA211
	Grigio Low Balloon 55	55 x 25	Ø 42	6	50	GW212	GN212	GA212
	Grigio Low Balloon 73	73 x 33	Ø 58	10	120	GW213	GN213	GA213
	Grigio Low Balloon 95	95 x 44	Ø 77	16	275	GW214	GN214	GA214
	Grigio Low Balloon 114	114 x 54	Ø 97	26	495	GW215	GN215	GA215
	Grigio Tall Balloon 40	40 x 50	Ø 29	5	50	GW220	GN220	GA220
	Grigio Tall Balloon 55	55 x 68	Ø 41	9	130	GW221	GN221	GA221
	Grigio Tall Balloon 74	74 x 92	Ø 54	20	580	GW222	GN222	GA222
	Grigio Egg Pot 32	32 x 29	Ø 28	2	27	GW300	GN300	GA300
	Grigio Egg Pot 40	40 x 36	Ø 35	3	52	GW301	GN301	GA301
	Grigio Egg Pot 50	50 x 45	Ø 44	6	101	GW302	GN302	GA302
	Grigio Egg Pot 60	60 x 54	Ø 53	9	175	GW303	GN303	GA303

# GRIGIO



Shape	Name	Size	Opening	Weight	Volume	Antique White	Natural Concrete	Anthracite
	Grigio New Egg Pot 36	36 x 31	Ø 30	3	30	GW310	GN310	GA310
	Grigio New Egg Pot 45	45 x 38	Ø 37	4	57	GW311	GN311	GA311
	Grigio New Egg Pot 55	55 x 46	Ø 47	6	105	GW312	GN312	GA312
	Grigio New Egg Pot 65	65 x 54	Ø 55	10	165	GW313	GN313	GA313
	Grigio New Egg Pot 80	80 x 66	Ø 68	16	226	GW314	GN314	GA314
	Grigio New Egg Pot 94	94 x 80	Ø 83	28	378	GW315	GN315	GA315
	Grigio New Egg Pot Low 80	80 x 47	Ø 72	13	250	GW320	GN320	GA320
	Grigio New Egg Pot Low 94	94 x 56	Ø 84	20	360	GW321	GN321	GA321
	Grigio New Egg Pot Low 110	110 x 65	Ø 100	27	600	GW322	GN322	GA322
	Grigio Tall Egg Pot 30	30 x 35	Ø 24	3	24	GW330	GN330	GA330
	Grigio Tall Egg Pot 40	40 x 47	Ø 33	5	56	GW331	GN331	GA331
	Grigio Tall Egg Pot 52	52 x 61	Ø 44	10	123	GW332	GN332	GA332
	Grigio Tall Egg Pot 68	68 x 80	Ø 58	18	276	GW333	GN333	GA333
	Grigio Tall Egg Pot 88	88 x 103	Ø 77	27	595	GW334	GN334	GA334
	Grigio Modern Vase 70	30 x 70	Ø 21	6	46	GW400	GN400	GA400
	Grigio Modern Vase 90	42 x 90	Ø 31	10	116	GW401	GN401	GA401
	Grigio Modern Vase 110	55 x 110	Ø 41	17	243	GW402	GN402	GA402
	Grigio Modern Pot 34	34 x 34	Ø 24	3	29	GW410	GN410	GA410
	Grigio Modern Pot 44	44 x 44	Ø 35	5	62	GW411	GN411	GA411
	Grigio Modern Pot 55	55 x 55	Ø 44	10	122	GW412	GN412	GA412
	Grigio Modern Pot 68	68 x 68	Ø 56	18	231	GW413	GN413	GA413
	Grigio Modern Bowl 50	50 x 31	Ø 40	5	58	GW420	GN420	GA420
	Grigio Modern Bowl 60	60 x 37	Ø 50	9	99	GW421	GN421	GA421
	Grigio Modern Bowl 74	74 x 45	Ø 61	13	183	GW422	GN422	GA422
	Grigio Modern Bowl 90	90 x 55	Ø 75	20	331	GW423	GN423	GA423
	Grigio Modern Bowl 110	110 x 67	Ø 92	27	605	GW424	GN424	GA424
	Grigio Elena 50	50 x 31	Ø 39	4	40	GW500	GN500	GA500
	Grigio Elena 70	70 x 44	Ø 56	9	124	GW501	GN501	GA501
	Grigio Elena 90	90 x 57	Ø 73	15	280	GW502	GN502	GA502
	Grigio Elena 120	120 x 75	Ø 95	40	650	GW503	GN503	GA503
	Grigio Bowl 40	40 x 18	Ø 34	2	12	GW540	GN540	GA540
	Grigio Bowl 50	50 x 21	Ø 43	4	25	GW541	GN541	GA541
	Grigio Cylinder 48	48 x 32	Ø 40	5	58	GW510	GN510	GA510
	Grigio Cylinder 60	60 x 41	Ø 50	9	116	GW511	GN511	GA511
	Grigio Cylinder 80	80 x 61	Ø 66	20	307	GW512	GN512	GA512
	Grigio Vase 68	36 x 68	Ø 30	6	53	GW530	GN530	GA530
	Grigio Vase 90	47 x 90	Ø 39	11	120	GW531	GN531	GA531
	Grigio Longtail 45	45 x 20 x 15	39 x 17	2	8	GW535	GN535	GA535
	Grigio Longtail 65	65 x 32 x 20	58 x 25	4	23	GW536	GN536	GA536

# TERRENO

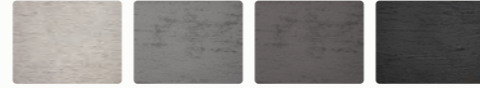

Shape	Name	Size	Opening	Weight	Volume	Sand	Clay	Ash Brown	Earth
	Terreno Cube 30	30 x 30 x 30	24 x 24	4	27	TS101	TC101	TA101	TE101
	Terreno Cube 40	40 x 40 x 40	33 x 33	7	64	TS102	TC102	TA102	TE102
	Terreno Cube 50	50 x 50 x 50	42 x 42	11	125	TS103	TC103	TA103	TE103
	Terreno Cube 60	60 x 60 x 60	50 x 50	18	216	TS104	TC104	TA104	TE104
	Terreno High Cube 80	30 x 30 x 80	33 x 33	12	160	TS110	TC110	TA110	TE110
	Terreno High Cube 100	40 x 40 x 100	24 x 24	9	72	TS111	TC111	TA111	TE111
	Terreno Divider 64	69 x 26 x 64	63 x 20	12	115	TS130	TC130	TA130	TE130
	Terreno Divider 68	80 x 30 x 68	73 x 23	14	163	TS131	TC131	TA131	TE131
	Terreno Divider 90	95 x 34 x 90	88 x 27	25	290	TS132	TC132	TA132	TE132
	Terreno Box 60	60 x 20 x 20	54x14	3	24	TS150	TC150	TA150	TE150
	Terreno Box 80	80 x 30 x 30	73x23	7	72	TS151	TC151	TA151	TE151
	Terreno Box 90	90 x 40 x 40	83x33	12	144	TS152	TC152	TA152	TE152
	Terreno Box 100	100 x 50 x 50	92x42	17	250	TS153	TC153	TA153	TE153
	Terreno Balloon 30	30 x 30	Ø 21	2	16	TS200	TC200	TA200	TE200
	Terreno Balloon 42	42 x 42	Ø 31	5	40	TS201	TC201	TA201	TE201
	Terreno Balloon 55	55 x 55	Ø 42	9	90	TS202	TC202	TA202	TE202
	Terreno Balloon 70	70 x 70	Ø 58	21	210	TS203	TC203	TA203	TE203
	Terreno Low Balloon 26	26 x 13	Ø 21	1	6	TS210	TC210	TA210	TE210
	Terreno Low Balloon 40	40 x 18	Ø 30	4	20	TS211	TC211	TA211	TE211
	Terreno Low Balloon 55	55 x 25	Ø 42	7	50	TS212	TC212	TA212	TE212
	Terreno Low Balloon 73	73 x 33	Ø 58	11	120	TS213	TC213	TA213	TE213
	Terreno Low Balloon 95	95 x 44	Ø 77	17	275	TS214	TC214	TA214	TE214
	Terreno Low Balloon 114	114 x 54	Ø 97	28	495	TS215	TC215	TA215	TE215
	Terreno Tall Balloon 40	40 x 50	Ø 29	6	50	TS220	TC220	TA220	TE220
	Terreno Tall Balloon 55	55 x 68	Ø 41	10	130	TS221	TC221	TA221	TE221
	Terreno Tall Balloon 74	74 x 92	Ø 54	22	580	TS222	TC222	TA222	TE222
	Terreno New Egg Pot 36	36 x 31	Ø 30	4	30	TS310	TC310	TA310	TE310
	Terreno New Egg Pot 45	45 x 38	Ø 37	5	57	TS311	TC311	TA311	TE311
	Terreno New Egg Pot 55	55 x 46	Ø 47	8	105	TS312	TC312	TA312	TE312
	Terreno New Egg Pot 65	65 x 54	Ø 55	12	165	TS313	TC313	TA313	TE313
	Terreno New Egg Pot 80	80 x 66	Ø 68	18	226	TS314	TC314	TA314	TE314
	Terreno New Egg Pot 94	94 x 80	Ø 83	31	378	TS315	TC315	TA315	TE315
	Terreno New Egg Pot Low 80	80 x 47	Ø 72	15	250	TS320	TC320	TA320	TE320
	Terreno New Egg Pot Low 94	94 x 56	Ø 84	22	360	TS321	TC321	TA321	TE321
	Terreno New Egg Pot Low 110	110 x 65	Ø 100	30	600	TS322	TC322	TA322	TE322
	Terreno Elena 50	50 x 31	Ø 39	5	40	TS500	TC500	TA500	TE500
	Terreno Elena 70	70 x 44	Ø 56	11	124	TS501	TC501	TA501	TE501
	Terreno Elena 90	90 x 57	Ø 73	17	280	TS502	TC502	TA502	TE502
	Terreno Elena 120	120 x 75	Ø 95	43	650	TS503	TC503	TA503	TE503
	Terreno Bowl 40	40 x 18	Ø 34	2	12	TS540	TC540	TA540	TE540
	Terreno Bowl 50	50 x 21	Ø 43	4	25	TS541	TC541	TA541	TE541
	Terreno Vase 68	36 x 68	Ø 30	7	53	TS530	TC530	TA530	TE530
	Terreno Vase 90	47 x 90	Ø 39	13	120	TS531	TC531	TA531	TE531

# BORDO



Shape	Name	Size	Opening	Weight	Volume	Sand	Clay	Earth
	Bordo Balloon 30	30 x 30	Ø 21	2	16	BS200	BC200	BE200
	Bordo Balloon 42	42 x 42	Ø 31	5	40	BS201	BC201	BE201
	Bordo Balloon 55	55 x 55	Ø 42	9	90	BS202	BC202	BE202
	Bordo Balloon 70	70 x 70	Ø 58	20	210	BS203	BC203	BE203
	Bordo Tall Balloon 40	40 x 50	Ø 29	6	50	BS220	BC220	BE220
	Bordo Tall Balloon 55	55 x 68	Ø 41	10	130	BS221	BC221	BE221
	Bordo Tall Balloon 74	74 x 92	Ø 54	22	580	BS222	BC222	BE222
	Bordo New Egg Pot 36	36 x 31	Ø 30	4	30	BS310	BC310	BE310
	Bordo New Egg Pot 45	45 x 38	Ø 37	5	57	BS311	BC311	BE311
	Bordo New Egg Pot 55	55 x 46	Ø 47	8	105	BS312	BC312	BE312
	Bordo New Egg Pot 65	65 x 54	Ø 55	12	165	BS313	BC313	BE313
	Bordo New Egg Pot 80	80 x 66	Ø 68	18	226	BS314	BC314	BE314
	Bordo New Egg Pot Low 80	80 x 47	Ø 72	15	250	BS320	BC320	BE320
	Bordo New Egg Pot Low 94	94 x 56	Ø 84	20	360	BS321	BC321	BE321
	Bordo New Egg Pot Low 110	110 x 65	Ø 100	29	600	BS322	BC322	BE322
		Bordo Modern Vase 70	30 x 70	Ø 21	7	46	BS400	BC400
Bordo Modern Vase 90		42 x 90	Ø 31	11	116	BS401	BC401	BE401
Bordo Modern Vase 110		55 x 110	Ø 41	17	243	BS402	BC402	BE402



# RUVIDO

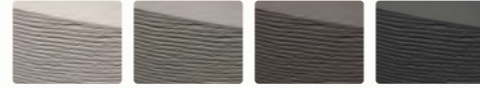

Shape	Name	Size	Opening	Weight	Volume	Sand	Clay	Ash Brown	Earth
	Ruvdo Combi 54	54 x 47	Ø 36	9	72	RS600	RC600	RA600	RE600
	Ruvdo Combi 80	80 x 70	Ø 55	18	253	RS601	RC601	RA601	RE601
	Ruvdo Organic 67	67 x 50	Ø 48	10	127	RS610	RC610	RA610	RE610
	Ruvdo Organic 80	80 x 60	Ø 57	15	220	RS611	RC611	RA611	RE611
	Ruvdo Organic 93	93 x 70	Ø 66	22	348	RS612	RC612	RA612	RE612
	Ruvdo Organic Low 67	67 x 30	Ø 48	6	76	RS615	RC615	RA615	RE615
	Ruvdo Organic Low 80	80 x 40	Ø 57	10	147	RS616	RC616	RA616	RE616
	Ruvdo Organic Low 93	93 x 50	Ø 66	16	249	RS617	RC617	RA617	RE617



# ARGENTO



Shape	Name	Size	Opening	Weight	Volume	Matt White	Black
	Argento Cube 30	30 x 30 x 30	24 x 24	3	27	AW101	AB101
	Argento Cube 40	40 x 40 x 40	33 x 33	6	64	AW102	AB102
	Argento Cube 50	50 x 50 x 50	42 x 42	10	125	AW103	AB103
	Argento Cube 60	60 x 60 x 60	50 x 50	16	216	AW104	AB104
	Argento High Cube 80	30 x 30 x 80	24 x 24	8	72	AW110	AB110
	Argento High Cube 100	40 x 40 x 100	33 x 33	11	160	AW111	AB111
	Argento Divider 64	69 x 26 x 64	63 x 20	11	115	AW130	AB130
	Argento Divider 68	80 x 30 x 68	73 x 33	13	163	AW131	AB131
	Argento Divider 90	95 x 34 x 90	88 x 27	23	290	AW132	AB132
	Argento Small Box 60	60 x 15 x 15	55 x 10	2	14	AW140	AB140
	Argento Small Box 80	80 x 20 x 20	74 x 14	4	32	AW141	AB141
	Argento Small Box 100	100 x 30 x 30	93 x 23	8	90	AW142	AB142
	Argento Box 60	60 x 20 x 20	54 x 14	2	24	AW150	AB150
	Argento Box 80	80 x 30 x 30	73 x 23	6	72	AW151	AB151
	Argento Box 90	90 x 40 x 40	83 x 33	10	144	AW152	AB152
	Argento Box 100	100 x 50 x 50	92 x 42	15	250	AW153	AB153
	Argento Box 120	120 x 50 x 50	111 x 41	21	300	AW154	AB154
	Argento Box 150	150 x 50 x 50	139 x 39	24	375	AW155	AB155
	Argento Balloon 30	30 x 30	Ø 21	2	16	AW200	AB200
	Argento Balloon 42	42 x 42	Ø 31	4	40	AW201	AB201
	Argento Balloon 55	55 x 55	Ø 42	8	90	AW202	AB202
	Argento Tall Balloon 40	40 x 50	Ø 29	5	50	AW220	AB220
	Argento Tall Balloon 55	55 x 68	Ø 41	9	130	AW221	AB221
	Argento New Egg Pot 36	36 x 31	Ø 30	3	30	AW310	AB310
	Argento New Egg Pot 45	45 x 38	Ø 37	4	57	AW311	AB311
	Argento New Egg Pot 55	55 x 46	Ø 47	6	105	AW312	AB312
	Argento New Egg Pot 65	65 x 54	Ø 55	10	165	AW313	AB313
	Argento Vase 68	36 x 68	Ø 30	6	53	AW530	AB530
	Argento Vase 90	47 x 90	Ø 39	11	120	AW531	AB531

# EXTRA



Shape	Name	Size	Weight	Antique White	Natural Concrete	Anthracite	Sand	Clay	Ash Brown	Earth
	Decoration Stone 60	60 x 42 x 33	6	-	-	-	DS850	DC850	DA850	DE850
	Decoration Stone 70	70 x 52 x 43	10	-	-	-	DS851	DC851	DA851	DE851
	Decoration Stone 80	80 x 62 x 53	14	-	-	-	DS852	DC852	DA852	DE852
	Wallhanger #1 - 40	40 x 35 x 8	1	-	-	-	WS860	WC860	-	WE860
	Wallhanger #1 - 50	50 x 43 x 8	1,5	-	-	-	WS863	WC863	-	WE863
	Wallhanger #2 - 40	35 x 40 x 8	1	-	-	-	WS861	WC861	-	WE861
	Wallhanger #2 - 50	43 x 50 x 8	1,5	-	-	-	WS862	WC862	-	WE862
	Wallhanger #3 - 40	35 x 40 x 8	1	-	-	-	WS862	WC862	-	WE862
	Wallhanger #3 - 50	43 x 50 x 8	1,5	-	-	-	WS865	WC865	-	WE865
	Coverplate Square 30	30 x 30	1,5	CW800	CN800	CA800	CS800	CC800	-	CE800
	Coverplate Square 40	40 x 40	2,5	CW801	CN801	CA801	CS801	CC801	-	CE801
	Coverplate Round 27	Ø 27	1	CW802	CN802	CA802	CS802	CC802	-	CE802
	Coverplate Round 37	Ø 37	1,5	CW803	CN803	CA803	CS803	CC803	-	CE803
	Coverplate Round 48	Ø 48	3	CW804	CN804	CA804	CS804	CC804	-	CE804
	Pot Feet Set (4)	10 x 10	-	PFW810	PFN810	PFA810	-	-	-	-

# FLEXIBLE PLASTIC LINER

Shape	Name	Size	Art. code
	Flexible Plastic Liner Round 15 x 15	15 x 15	PL830
	Flexible Plastic Liner Round 21 x 16	21 x 16	PL831
	Flexible Plastic Liner Round 25 x 15	25 x 15	PL832
	Flexible Plastic Liner Round 30 x 22	30 x 22	PL833
	Flexible Plastic Liner Round 35 x 25	35 x 25	PL834
	Flexible Plastic Liner Round 35 x 40	35 x 40	PL835
	Flexible Plastic Liner Round 40 x 30	40 x 30	PL836
	Flexible Plastic Liner Round 40 x 45	40 x 45	PL837
	Flexible Plastic Liner Round 45 x 35	45 x 35	PL838
	Flexible Plastic Liner Round 50 x 38	50 x 38	PL839
	Flexible Plastic Liner Round 55 x 40	55 x 40	PL840
	Flexible Plastic Liner Round 60 x 45	60 x 45	PL841
	Flexible Plastic Liner Round 65 x 48	65 x 48	PL842
	Flexible Plastic Liner Round 70 x 45	70 x 45	PL843
	Flexible Plastic Liner Round 80 x 60	80 x 60	PL844
	Flexible Plastic Liner Square 32 x 30	32 x 32 x 30	PL845
	Flexible Plastic Liner Square 38 x 30	38 x 38 x 30	PL846
	Flexible Plastic Liner Square 48 x 35	48 x 48 x 35	PL847
	Flexible Plastic Liner Rectangle 80 x 20	80 x 20 x 20	PL848





Ready to order?  
Scan here!

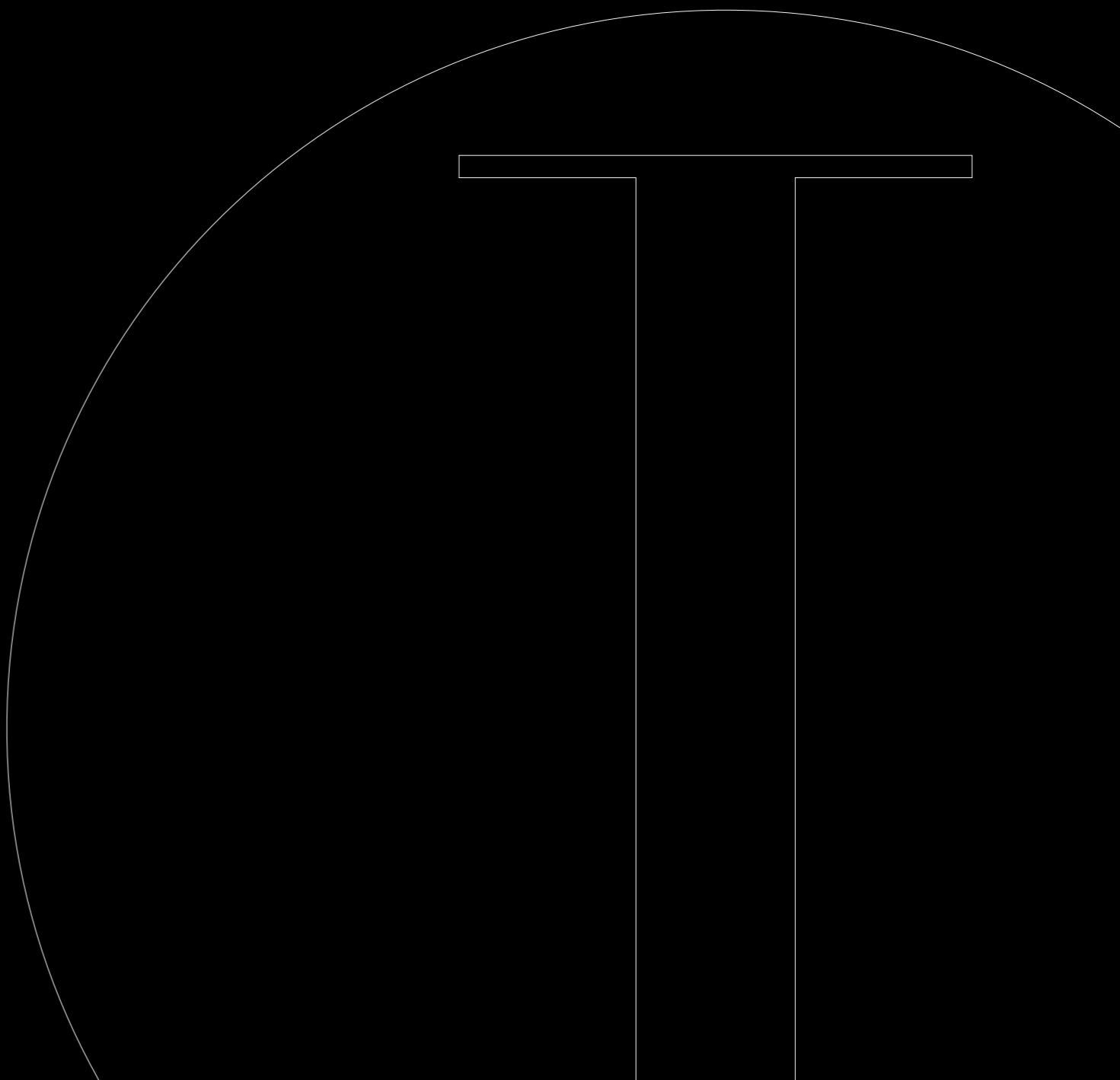



UUCALIFESTYLE